

Balancing and Settlement Code

BSC PROCEDURE

OVERVIEW OF TRADING ARRANGEMENTS

BSCP01

Version 24.3~~Version 24.0~~

Date 02 November 2023~~23 February 2023~~ DD MM YYYY

BSC Procedure 01

relating to

OVERVIEW OF TRADING ARRANGEMENTS

1. Reference is made to the Balancing and Settlement Code and, in particular, to the definition of “BSC Procedure” in Section X, Annex X-1 thereof.
2. This is BSC Procedure 01, Version 24.31~~Version 24.0~~ relating to Overview of Trading Arrangements.
3. This BSC Procedure is effective from ~~02 November 2023~~23 February 2023[DD MM YYYY].
4. This BSC Procedure has been approved by the Panel.

Intellectual Property Rights, Copyright and Disclaimer

The copyright and other intellectual property rights in this document are vested in Elexon or appear with the consent of the copyright owner. These materials are made available for you for the purposes of your participation in the electricity industry. If you have an interest in the electricity industry, you may view, download, copy, distribute, modify, transmit, publish, sell or create derivative works (in whatever format) from this document or in other cases use for personal academic or other non-commercial purposes. All copyright and other proprietary notices contained in the document must be retained on any copy you make.

All other rights of the copyright owner not expressly dealt with above are reserved.

No representation, warranty or guarantee is made that the information in this document is accurate or complete. While care is taken in the collection and provision of this information, Elexon Limited shall not be liable for any errors, omissions, misstatements or mistakes in any information or damages resulting from the use of this information or action taken in reliance on it.

AMENDMENT RECORD

Version	Date	Description of Changes	Changes Included	Mods/ Panel/ Committee Refs
1.0	08/08/2000	Go Active version	n/a	n/a
2.0	30/11/00	Work Outstanding at Go Active, resolution of inconsistencies, inclusion of consultation comments.	242,191,216	08/009
3.0	13/8/02	Change Proposals and Code Modifications for BSC Systems Release 2	CP563, CP572, CP630; P18A, P49	ISG/1
4.0	30/9/02	Code Modification P2	P2	ISG16/166 SVG17/208
5.0	27/08/02	Phase 2A (Dec 02) Release – Draft	CP629, CP639	ISG15/151 ISG11/093
6.0	25/02/03	February 03 Release	P71, P78	ISG 24/265 SVG24/311
7.0	24/06/03	June 03 Release	CP736	ISG17/177
8.0	04/11/03	November 03 Release	P107, P82	59/009 54/006
9.0	30/06/04	CVA Programme June 04 Release	CP945 CP854, CP971 P82 Removal	ISG40/003
10.0	03/11/04	CVA Programme Nov 04 Release	CP1032	TDC58/03
11.0	23/02/05	CVA Programme Feb 05 Release	CP1091 BETTA 6.3 P140	
12.0	26/06/08	June 08 Release	CP1223	SVG84/02 ISG84/01 TDC109/01 PAB84/11
13.0	05/11/09	November 09 Release	P217	Panel 142/06
14.0	03/11/11	November 11 Release	P253	ISG127/02 SVG127/13
15.0	25/06/15	June 15 Release	CP1426	ISG166/06, SVG169/05
16.0	29/06/17	June 17 Release	P350	ISG194/02 SVG196/03
17.0	02/11/17	November 17 Release	P342 Alternative	ISG198/04 SVG200/03
18.0	29/03/19	29 March 19 Standalone Release	P369	P285/12
19.0	11/12/19	11 December 2019 Standalone Release	CP1517	ISG220/01, SVG223/03

Version	Date	Description of Changes	Changes Included	Mods/ Panel/ Committee Refs
20.0	27/02/2020	27 February 2020 Release	P394 Self-Governance	P297/07
21.0	01/04/2020	1 April 2020 Standalone Release	P354, P388	ISG227/04, SVG 229/07
22.0	01/09/2021	1 September 2021 Non-Standard Release	P420	P316/05
23.0	30/06/2022	30 June 2022 Standard Release	P375, P433	P309/06, P322/05
24.0	23/02/2023	23 February 2022 Standard Release	P376	P314/06
24.1	13/07/2023	02 November 2023 Standard Release	P395	P340/05
24.3	23/11/2023	MHHS Programme		

CONTENTS

1	Introduction	7
1.1	Purpose and Scope of the Procedure	7
1.2	Main Users of the Procedure and their Responsibilities	7
1.3	Key Milestones	8
1.4	Balancing and Settlement Code Provision	8
1.5	Associated BSC Procedures	8
1.6	Overview of Trading Arrangements and Settlement Process	9
1.6.1	Introduction	9
1.7	Use of the Procedure	12
1.7.1	Description of Context and Process Diagrams	12
1.7.2	Overview of Settlement Timetable	12
1.8	Settlement Administration Agent Obligations with regard to input data	12
2	Acronyms and Definitions	13
2.1	Acronyms	13
2.2	Definitions	13
3	Process Diagrams	14
3.1	Trading Arrangements Context Diagram	14
3.2	Trading Processes prior to Settlement	16
3.3	Interim Information and Initial Volume Allocation / Settlement Runs	17
3.4	Reconciliation and Final Reconciliation Volume Allocation / Settlement Runs	19
3.5	Replacement Reserve Process	22
4	Interface and Timetable Information	23
4.1	Interim Information and Initial Settlement Timetable and Settlement Reports	23
4.2	Reconciliation Timetable and Settlement Reports	29
4.3	Produce Payment Calendar and SAA Settlement Calendar (transferred to BSCP301)	31
5	Appendices	31
5.1	Interim Information Settlement Run	31
5.2	Initial Settlement Run	32
1	Introduction	6
1.1	Purpose and Scope of the Procedure	6
1.2	Main Users of the Procedure and their Responsibilities	6
1.3	Key Milestones	7
1.4	Balancing and Settlement Code Provision	7
1.5	Associated BSC Procedures	7
1.6	Overview of Trading Arrangements and Settlement Process	8
1.6.1	Introduction	8
1.7	Use of the Procedure	10
1.7.1	Description of Context and Process Diagrams	10

1.7.2	Overview of Settlement Timetable	11
1.8	Settlement Administration Agent Obligations with regard to input data	11
2	Acronyms and Definitions	12
2.1	Acronyms	12
2.2	Definitions	12
3	Process Diagrams	13
3.1	Trading Arrangements Context Diagram	13
3.2	Trading Processes prior to Settlement	14
3.3	Interim Information and Initial Volume Allocation / Settlement Runs	15
3.4	Reconciliation and Final Reconciliation Volume Allocation / Settlement Runs	16
3.5	Replacement Reserve Process	17
4	Interface and Timetable Information	18
4.1	Interim Information and Initial Settlement Timetable and Settlement Reports	18
4.2	Reconciliation Timetable and Settlement Reports	24
4.3	Produce Payment Calendar and SAA Settlement Calendar (transferred to BSCP301)	26
5	Appendices	26
5.1	Interim Information Settlement Run	26
5.2	Initial Settlement Run	27

1 Introduction

1.1 Purpose and Scope of the Procedure

This overview describes the component activities of the Trading Arrangements detailed in the Code, from submission of trading data prior to Gate Closure through to final exchange of funds up to fourteen months later. This is in the form of a set of overview process diagrams and a schedule of trading activities (i.e., the Settlement process timetable).

As this document is an overview, process details relating to validation and handling of errors at interfaces are excluded from the process diagrams and schedules. The actions taken by the Settlement Administration Agent in the event of missing or invalid data are described in [Appendices 5.1](#) and [5.2](#).

1.2 Main Users of the Procedure and their Responsibilities

The main users of this procedure are:

- (a) Party Agents
- (b) Parties
- (c) The Central Registration Agent (CRA)
- (d) The Energy Contract Volume Aggregation Agent (ECVAA)
- (e) The Balancing Mechanism Reporting Agent (BMRA)
- (f) The Central Data Collection Agent (CDCA)
- (g) The Settlement Administration Agent (SAA)
- (h) The Funds Administration Agent (FAA)
- (i) The Supplier Volume Allocation Agent (SVAA)
- (j) The Dispute Administrator (DA)
- (k) The Teleswitch Agent
- (l) Supplier Agents
- (m) Market Index Data Providers
- (n) The NETSO

All of the above Parties have a responsibility for fulfilling their obligations under the Code, either directly or via other contractual arrangements with signatories to the Code, in respect of ensuring adherence to the Settlement process timetable.

1.3 Key Milestones

The key milestones in this procedure are defined as follows:

- (a) Interim Information and Initial Settlement ([Section 4.1](#))
- (b) Reconciliation and Final Settlement ([Section 4.2](#))

1.4 Balancing and Settlement Code Provision

This BSCP should be read in conjunction with the Code. This BSCP has been produced in accordance with the provisions of the Code. In the event of an inconsistency between the provisions of this BSCP and the Code, the provisions of the Code shall prevail.

1.5 Associated BSC Procedures

[\[MHHS\]](#) The following is a list of BSCPs covering activities and interfaces that are dependent on the Settlement timetable:

BSCP03	Data estimation and substitution for CVA
BSCP04	BM Unit Metered Volumes for Interconnector Users
BSCP11	Trading Disputes
BSCP65	Registration of BSC Parties and Exit Procedures
BSCP68	Transfer of Registration of metering systems between CMRS and SMRS
BSCP71	Submission of ECVNs and MVRNs
BSCP301	Clearing, Invoicing and Payment
BSCP501	Supplier Meter Registration Service
BSCP502	Half Hourly Data Collection for Metering Systems Registered in SMRS
BSCP503	Half Hourly Data Aggregation for Metering Systems Registered in SMRS
BSCP504	Non Half Hourly Data Collection for Metering Systems Registered in SMRS
BSCP505	Non Half Hourly Data Aggregation for Metering Systems Registered in SMRS
BSCP508	Supplier Volume Allocation Agent
BSCP602	SVA Metering System & Asset Metering System Register
BSCP603	Meter Operations and Data Collection for Asset Metering Systems
BSCP700	Unmetered Supplier Data Services
BSCP701	Smart Data Service
BSCP702	Advanced Data Service
BSCP703	BSC Central Systems for MHHS Metering Systems

BSCP706Supplier Meter Registration Service for MHHS Metering Systems

1.6 Overview of Trading Arrangements and Settlement Process

1.6.1 Introduction

The Code sets out the obligations with which all Parties must comply and details the arrangements for participation in the balancing mechanism and the Settlement of balancing mechanism transactions and imbalances in Great Britain.

Seasonal Transmission Loss Factors (TLFs) in respect of a BSC Year will be derived and published on the Elexon Portal by no later than 31 December in the preceding BSC Year. Seasonal TLFs will be loaded into CRA no later than 5 WD before the start of the relevant BSC Season. SAA will access Seasonal TLFs for a Settlement Day via the shared SAA/CRA/CDCA database. Consequently Seasonal TLFs are not referenced in [Section 4](#), Interface and Timetable Information.

It is expected that Trading Parties will enter into bilateral contracts in advance of the Submission Deadline (the notification deadline for the purposes of submitting Energy Contract Volume and Meter Volume Reallocation Notifications for each Settlement Period as defined in Annex X-1). These bilateral contract volumes must be notified to the ECVAA no later than the Submission Deadline for the relevant Settlement Period if they are to be taken into account for the purposes of calculating energy imbalances for that Settlement Period, but may be submitted at any time in advance of the Submission Deadline for the relevant Settlement Period.

Prior to Gate Closure, some Lead Parties of BM Units must submit (and some Lead Parties of BM Units may choose to submit) a Final Physical Notification (FPN) to the National Electricity Transmission System Operator (NETSO). This is a minute by minute profile of the expected power output or consumption of the relevant generation or demand across each Settlement Period.

Lead Parties of BM Units may choose to participate in the Balancing Mechanism, i.e. provide balancing services actions for a particular Settlement Period. This willingness to operate at a level other than their FPN is demonstrated with the use of Balancing Mechanism Bids and Offers. An Offer indicates a willingness to increase the level of generation or reduce the level of demand. A Bid indicates a willingness to reduce the level of generation or increase the level of demand.

Lead Parties of BM Units may also choose to participate in the Replacement Reserve market, i.e. to provide balancing services actions, for a particular Settlement Period. This willingness to operate at a level other than their FPN is demonstrated with the use of Replacement Reserve Bids. Note a Replacement Reserve Bid can indicate either a willingness to increase the level of

generation or reduce the level of demand, or a willingness to reduce the level of generation or increase the level of demand.

Virtual Lead Parties, Asset Metering Virtual Lead Parties and Suppliers may take part in both the Balancing Mechanism and the Replacement Reserve markets. Virtual Lead Parties and Asset Metering Virtual Lead Parties will submit bids to provide balancing services actions through the mechanism of Secondary BM Units and Suppliers will do so through Additional BM Units. Both Secondary BM Units and Supplier Additional BM Units will be comprised of MSID Pairs; Secondary BM Units submitted by Asset Metering Virtual Lead Parties may also include AMSID Pairs. A MSID Pair must contain an Import MSID and will usually (but does not have to) contain an Export MSID. Similarly, an AMSID Pair must contain an Import AMSID and will usually (but does not have to) contain an Export AMSID. Virtual Lead Parties will submit MSID Pair Delivered volumes and, Asset Metering Virtual Lead Parties will submit MSID Pair Delivered volumes or AMSID Pair Delivered volumes to the BSC Central Systems for each accepted Balancing Mechanism Bid/Offer and Replacement Reserve Bid.

Suppliers and Virtual Lead Parties can opt their Additional and Secondary BM Units as a “Baselined BM Unit”. An FPN is still submitted to National Grid for dispatch purposes, but the FPN is not used to calculate Non-Delivery Charges. Instead Settlement systems calculate their own FPN-equivalent (the “Settlement Expected Volume”). The Lead Party specifies (when they allocate each MSID Pair or AMSID Pair to the Baselined BM Unit) how that MSID Pair or AMSID Pair’s contribution to the Settlement Expected Volume should be calculated:

1. Baselined MSID Pairs (or AMSID Pairs): SVAA will use historic metered data to calculate the baseline consumption for the MSID Pair or AMSID Pair (in accordance with a Baselining Methodology Document agreed by the BSC Panel);
2. Non-Baselined MSID Pairs (or AMSID Pairs): The Lead Party calculates the FPN-equivalent, and submits a total figure (per BM Unit and Settlement Period) for all the non-Baselined MSID Pairs and AMSID Pairs; or
3. Inactive MSID Pairs (or AMSID Pairs): temporarily excluded from the BM Unit (for Settlement purposes). Secondary BM Units only.

The NETSO takes the submitted FPNs, Bid/Offer data and Replacement Reserve Bids, together with its own forecast of demand and knowledge of system constraints in the relevant Settlement Period and identifies which Bids and/or Offers it needs to accept in order to control the national and local balance of generation and demand. For each Bid-Offer Acceptance (BOA) the NETSO indicates whether the Acceptance was potentially taken to resolve a transmission constraint using a System Operator Flag (SO-Flag). If the BOA was potentially taken to resolve a transmission constraint the SO-Flag is set to TRUE (and is set to FALSE if the NETSO considers the BOA was not taken to resolve a transmission constraint). The SO-Flag is used to determine whether a BOA should retain its price in the calculation of the main Energy Imbalance Price. SO-Flagged BOAs with a price which is more expensive (from the point of view of the System) than the most expensively priced unflagged balancing action are unpriced. BOAs with a less expensive price (from the point of view of the System) than the most expensively priced unflagged action retain their price.

For each Settlement Period the actual volume of energy transferred will be measured for each BM Unit and compared to the expected contracted volume (as notified to the ECVAA) adjusted

for any accepted Bids and/or Offers. The resulting energy imbalance will be settled using the relevant cash out price calculated by SAA.

In addition to these payments and charges, there is also an information imbalance charge which is applied to the difference between the metered output of a BM Unit and the level at which a BM Unit was expected to operate given its FPN adjusted for any accepted Offers and Bids.

All Balancing Mechanism and Imbalance Settlement calculations will be performed by the SAA who will then issue information to the FAA detailing the amounts payable to or by Trading Parties with respect to each Settlement Period.

For accepted Secondary BM Unit balancing services actions and for non BM Unit Applicable Balancing Services actions provided to the NETSO outside of the BM, the SVAA will receive MSID Pair Delivered Volume Data or AMSID Pair Delivered Volume Data and will calculate the appropriate corrections to the imbalance position of each Supplier whose (Primary) BM Unit(s) contain MSID(s) that have been used to provide balancing services actions and send these, along with Secondary BM Unit Delivered Volumes and Supplier BM Unit Non BM Unit ABSVD to the SAA for use in Settlement.

Suppliers who operate within Supplier Volume Allocation appoint agents to carry out certain functions required by the Code. These agents include Data Collectors (half hourly and non half hourly) and Data Aggregators (half hourly and non half hourly). SVA Meter Operator Agents are appointed in accordance with the Retail Energy Code Metering Operation Schedule to carry out certain functions as required by the REC. Suppliers register their Agents with the relevant Supplier Meter Registration Service (SMRS).

Asset Metering Virtual Lead Parties [and Suppliers](#) appoint Meter Operator Agents or Asset Metering Meter Operator Agents, and Half Hourly Data Collectors and (where appropriate may also appoint Asset Metering Half Hourly Data Collectors) to carry out certain functions relating to SVA Asset Meters registered with the SVAA required by the Code. Asset Metering Virtual Lead Parties [and Suppliers](#) register Meter Operator Agents and Half Hourly Data Collectors with the SVAA.

The Data Collectors collect and process meter readings (including data estimation). Settlement of Non Half Hourly Metering Systems is performed on the basis of profiled Annualised Advance (AA) and Estimated Annual Consumption (EAC) values for onward submission to the Non Half Hourly Data Aggregator. Half Hourly Data Collectors pass validated half hourly metered consumption values to the Half Hourly Data Aggregator.

Half Hourly Data Collectors collect and process Asset Meter readings (including data estimation), which they provide directly to the SVAA (and not to the HHDA). Where an Asset Metering Half Hourly Data Collector is also appointed, they shall pass Asset Meter readings to the HHDC to process and provide to the SVAA.

Half Hourly Data Aggregators will send HH Metering System Metered Volume Data to the SVAA for each MSID notified to it by the SVAA, for use in the Secondary BM Units Settlement calculations.

The Data Aggregators aggregate the meter readings (half hourly) or AA and EAC values (non half hourly) received from the Data Collectors according to the registration data held by the SMRA. The Data Aggregators provide the aggregated data to the SVAA.

1.7 Use of the Procedure

1.7.1 Description of Context and Process Diagrams

The Trading Arrangements context diagram shown in [section 3.1](#) shows only the main processes and interfaces between Parties, Party Agents, the ECVAA, BMRA, CDCA, the NETSO, the MIDPs, the Settlement Administration Agent (SAA), the Supplier Volume Allocation Agent (SVAA) and the Funds Administration Agent (FAA).

The Context and Process Diagrams provide a summary of the activities and interactions of the main parties involved in the trading process, shown without timescales and do not cover non-Settlement dependent processes and dataflows. Please note however, whilst a time-line is implied from left to right across the page, the relationship between process schedules may not be accurately reflected here. To ensure as much clarity as possible, some minor dataflows and reports are not shown in the diagrams.

[Section 3.2](#) shows the trading processes prior to Settlement

[Section 3.3](#) illustrates the Interim Information and Initial Volume Allocation / Settlement Runs

[Section 3.4](#) shows the three Reconciliation and Final Reconciliation Volume Allocation / Settlement Run Processes.

1.7.2 Overview of Settlement Timetable

[Table 4.1](#) shows the tasks from Energy Contract Volume and Meter Volume Reallocation Notification through to the Interim Information Volume Allocation Run by the SVAA, the Interim Information Settlement Run by SAA, the Initial Volume Allocation Run by SVAA, the Initial Settlement Run by SAA through to Initial Funds Transfer by FAA.

[Table 4.2](#) details the three Reconciliation Runs through to the Final Reconciliation Settlement Run at 14 months.

[Table 4.3](#) (the annual processes involved in the production of the Payment Calendar and SAA Settlement Calendar) has been transferred to BSCP301.

1.8 Settlement Administration Agent Obligations with regard to input data

In accordance with the Code, the SAA has an obligation to receive and validate input data (described in more detail in the Settlement timetable) from the following Parties and Agents:

National Electricity Transmission System Operator;

Balancing Mechanism Reporting Agent;

Central Data Collection Agent;

Energy Contract Volume Aggregation Agent;

Interconnector Administrators;

Supplier Volume Aggregation Agent;
Central Registration Agent; and
Market Index Data Providers.

The actions to be taken when data is found to be missing or invalid (where not already defined in the Code) for inputs into Settlement are described in [Appendices 5.1](#) and [5.2](#).

2 Acronyms and Definitions

2.1 Acronyms

A list of acronyms can be found in Annex X of the Code.

The following acronym is used in this Procedure:

T is the Payment Date for all Timetabled Reconciliation Settlement Runs, as set by the Payment Calendar, and expressed in Working Days from the relevant Settlement Day. In order to allow for days when processing does not take place such as Bank Holidays, the value of T will fall within a “window” as defined in [4.2](#).

2.2 Definitions

A list of definitions can be found in Annex X of the Code. Definitions used in this Procedure (if any) are as follows:

Dynamic Data – Data included in the Dynamic Data Set.

QAS - Applicable Balancing Services Volume

IIR – Interim Information Run

3 Process Diagrams

3.1 **[MHHS]** Trading Arrangements Context Diagram

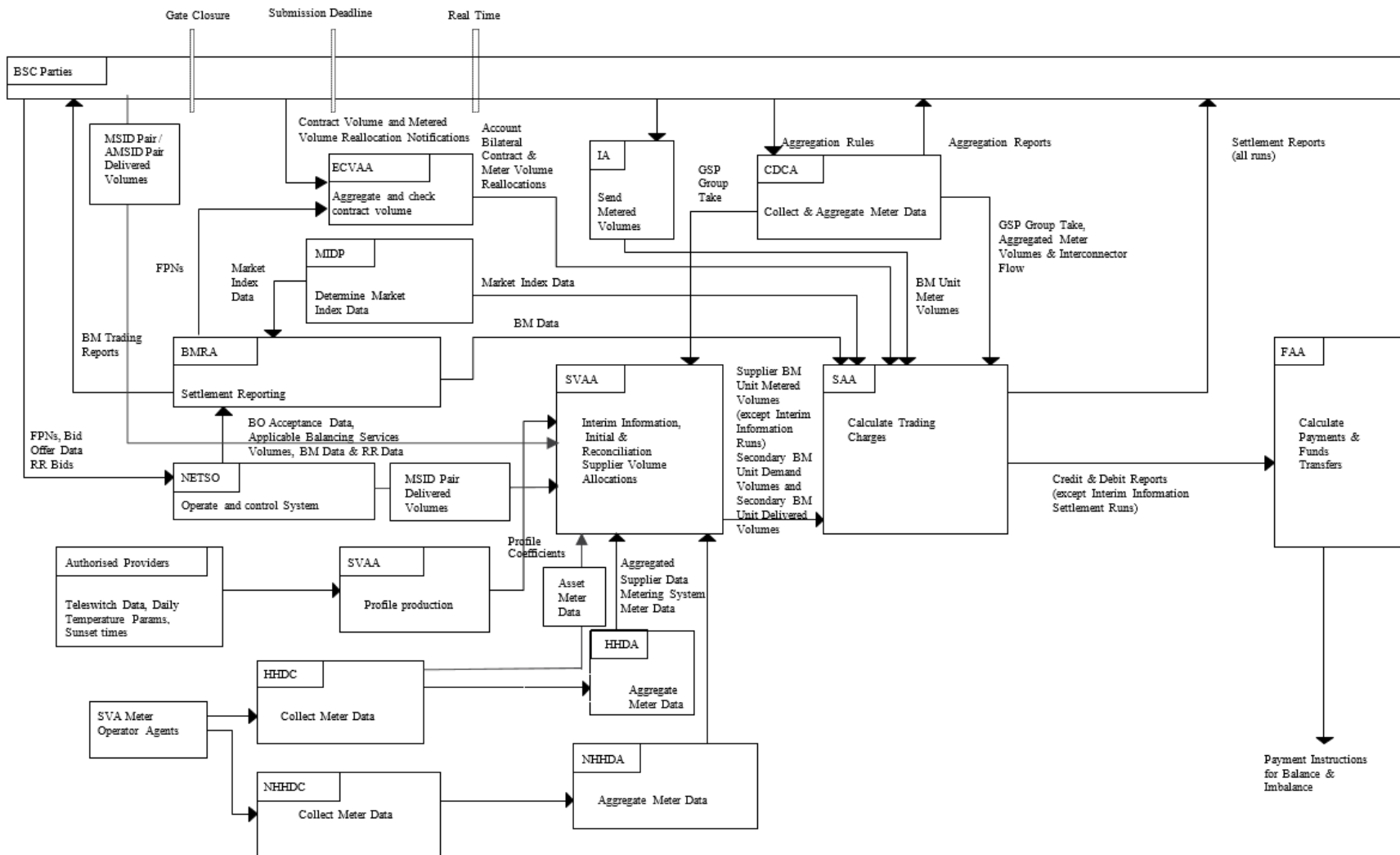

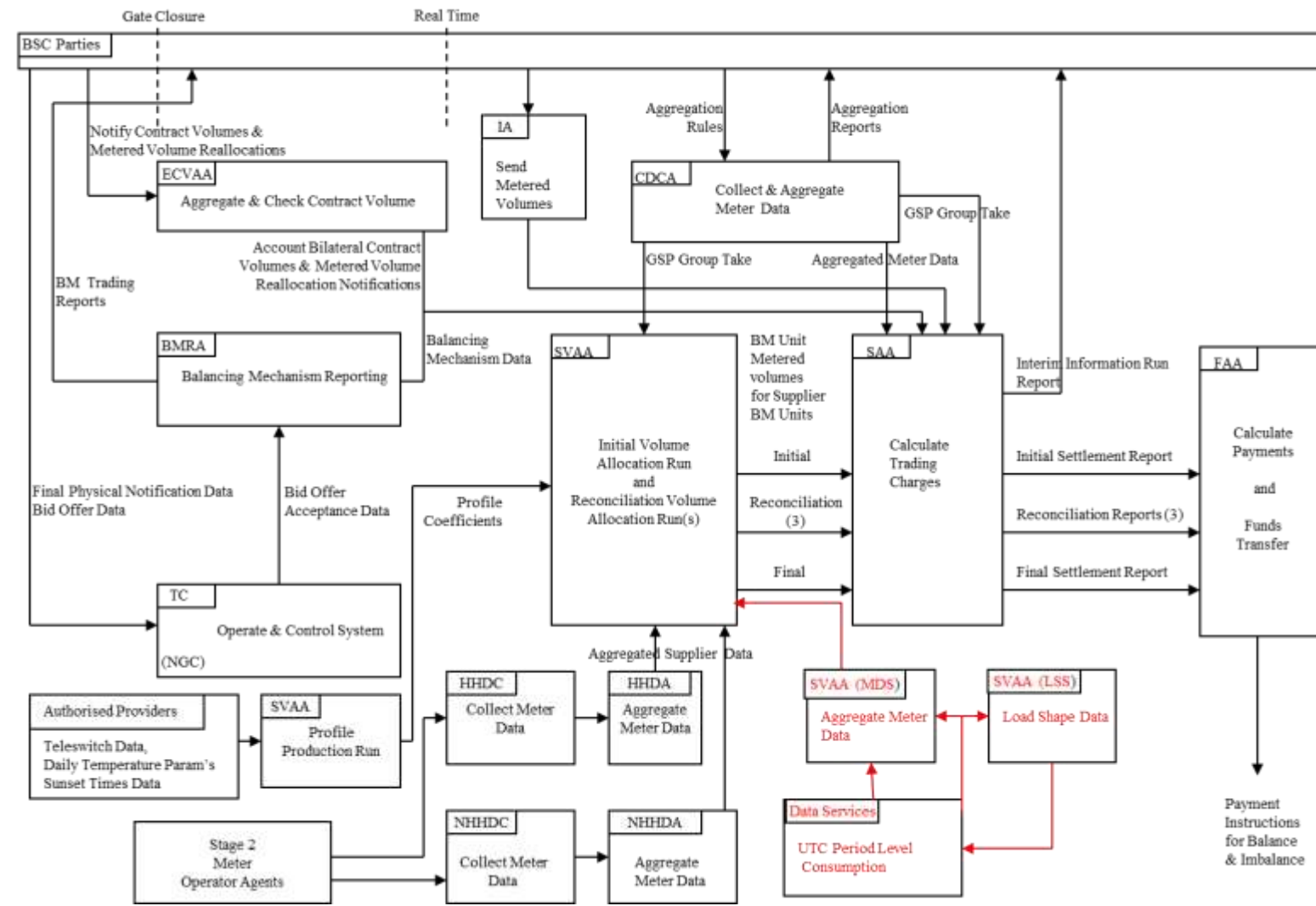

3.2 Trading Processes prior to Settlement

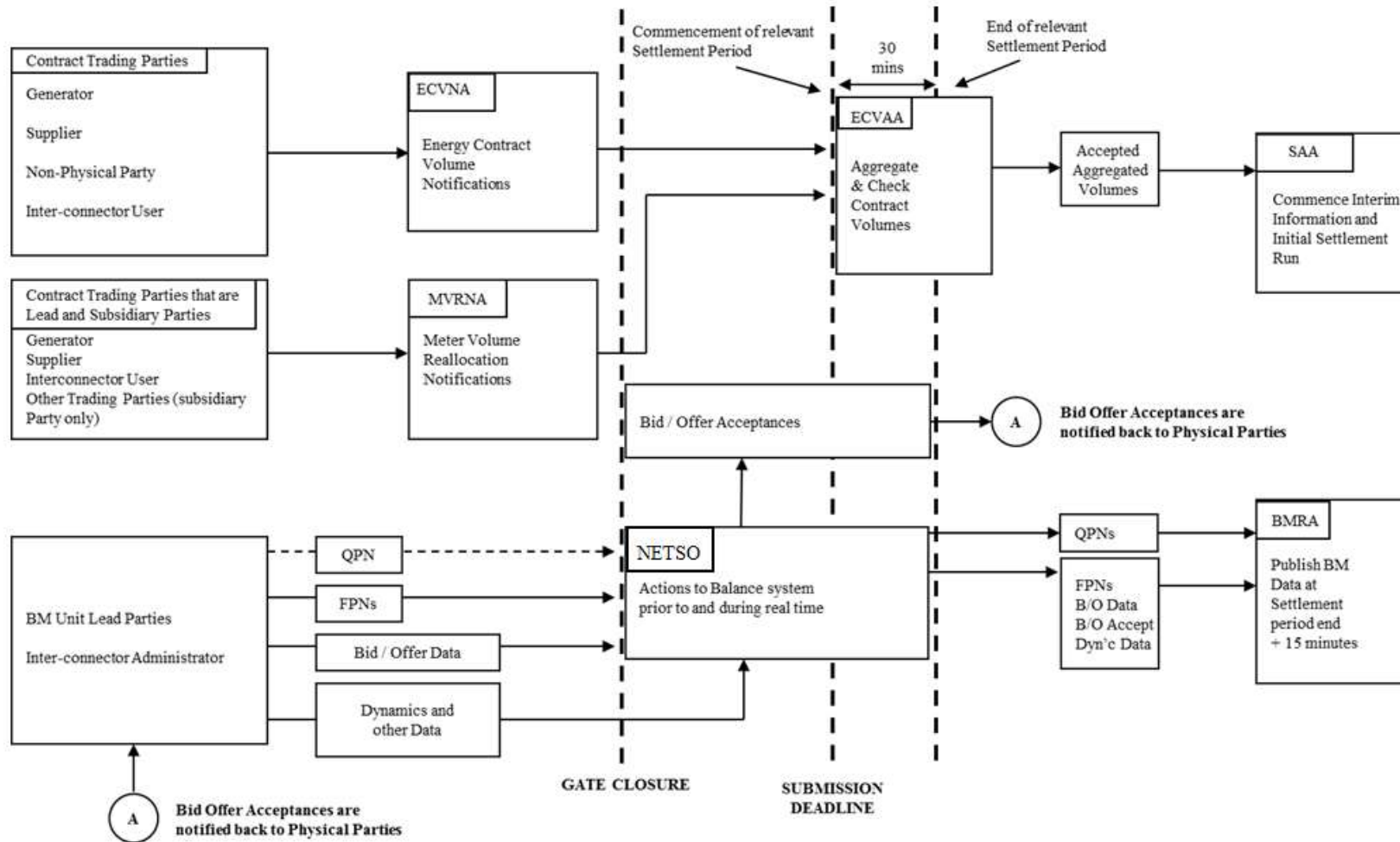

Please note that within this diagram, TC is the equivalent of NETSO.

3.3 Interim Information and Initial Volume Allocation / Settlement Runs

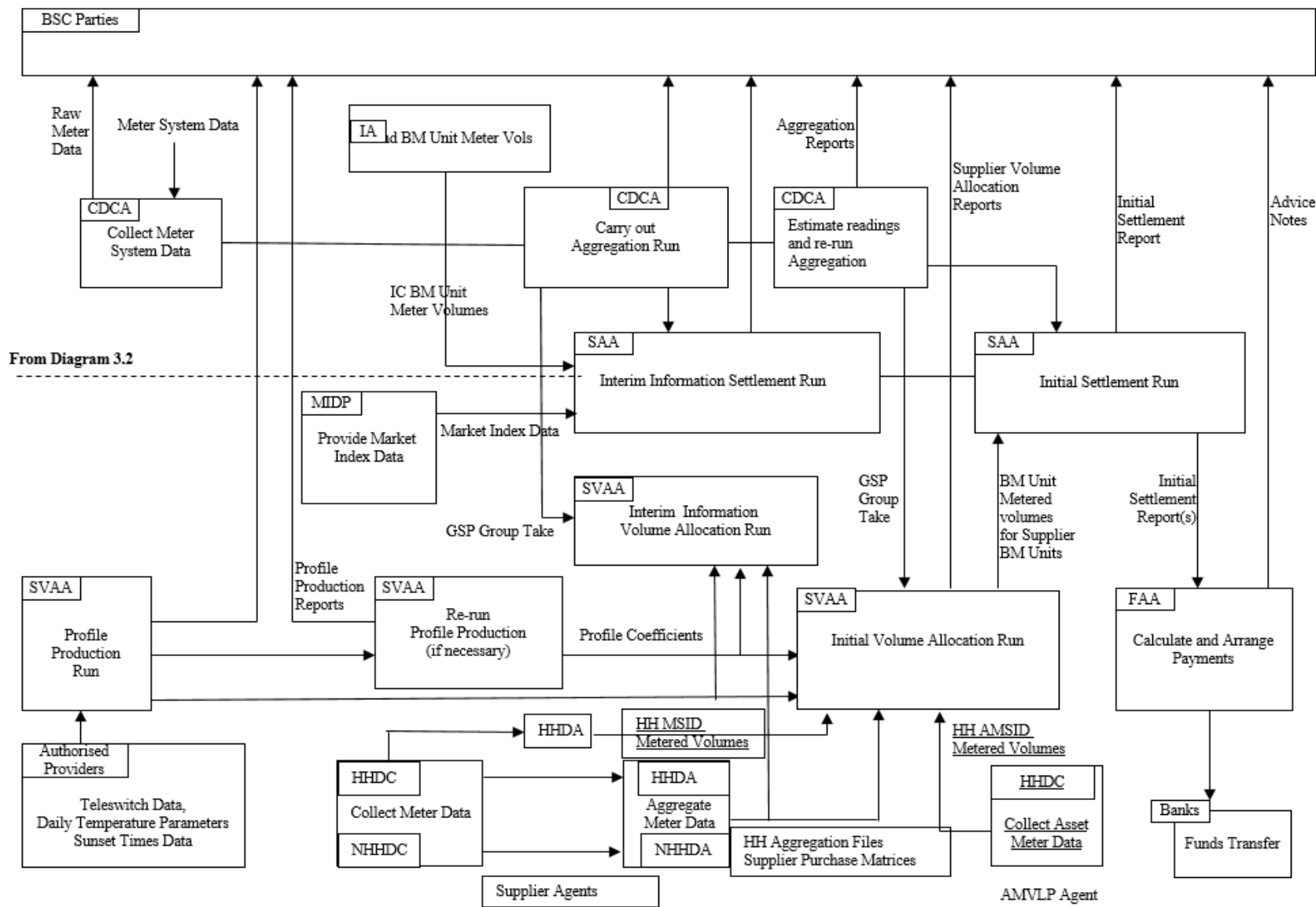

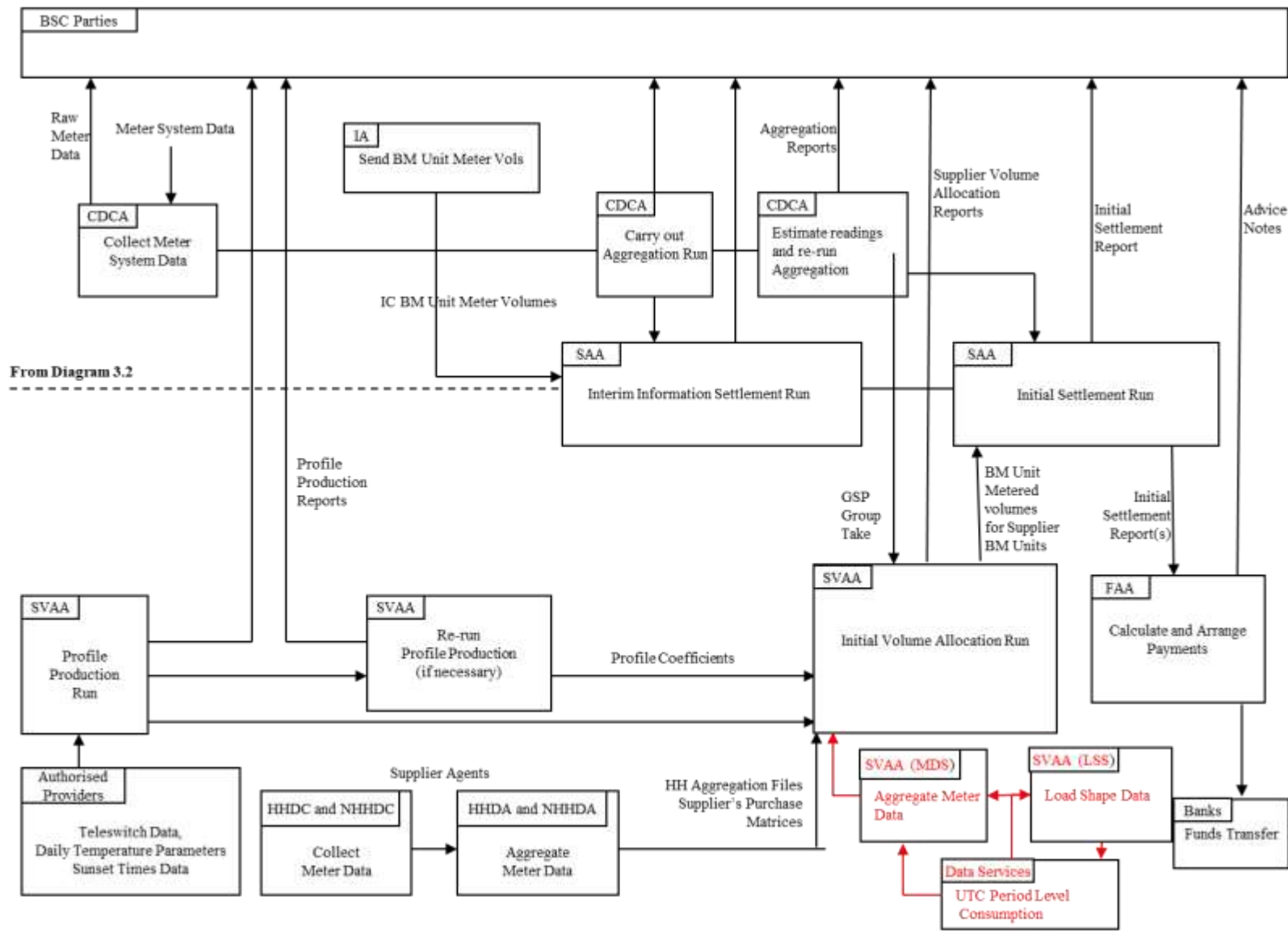

3.4 Reconciliation and Final Reconciliation Volume Allocation / Settlement Runs¹

¹ Where an upheld Trading Dispute is to be processed after the Final Reconciliation Settlement Run has been performed then a Post-Final Settlement Run or Extra-Settlement Determination may be required as described in BSCP11.

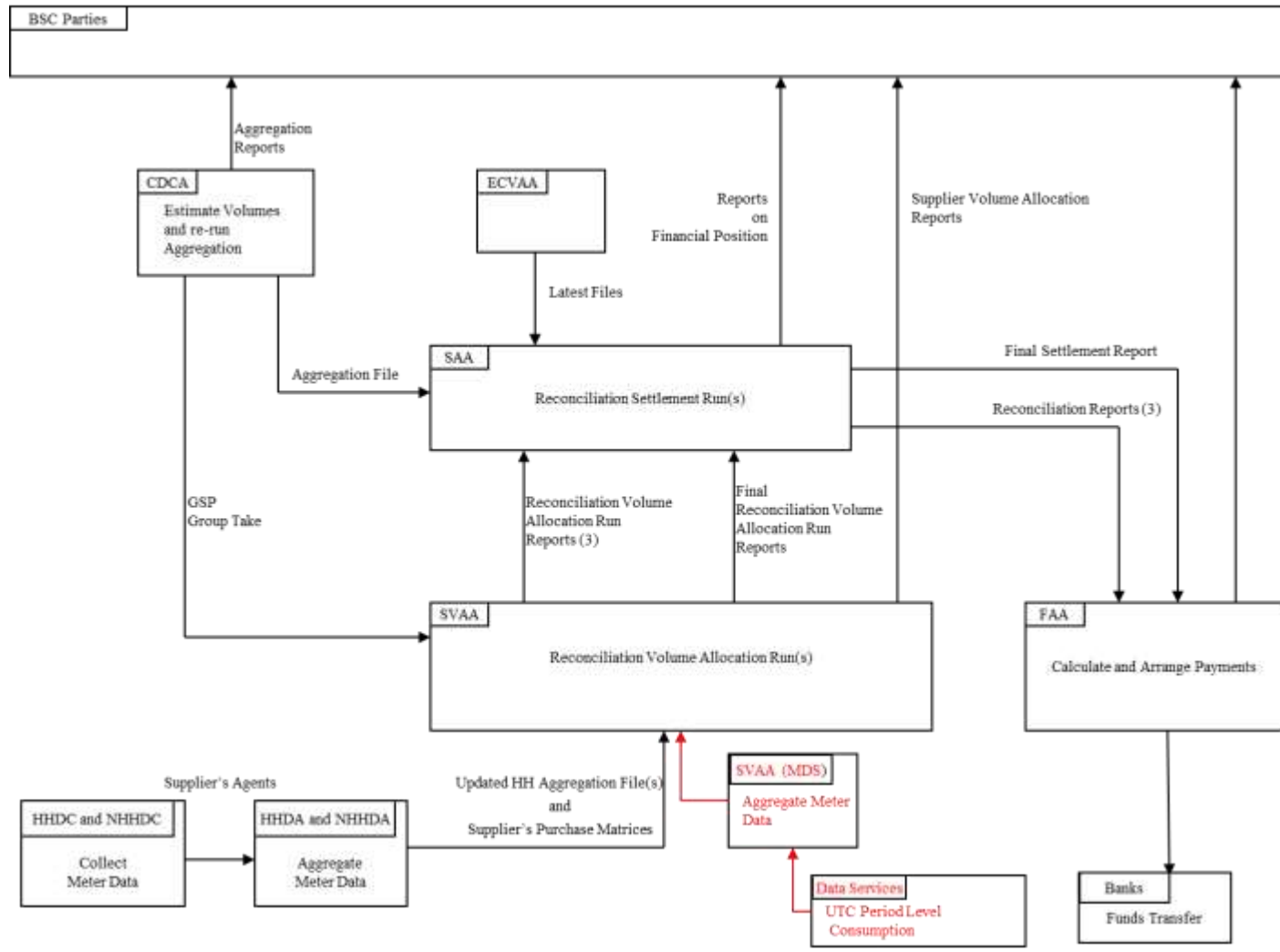

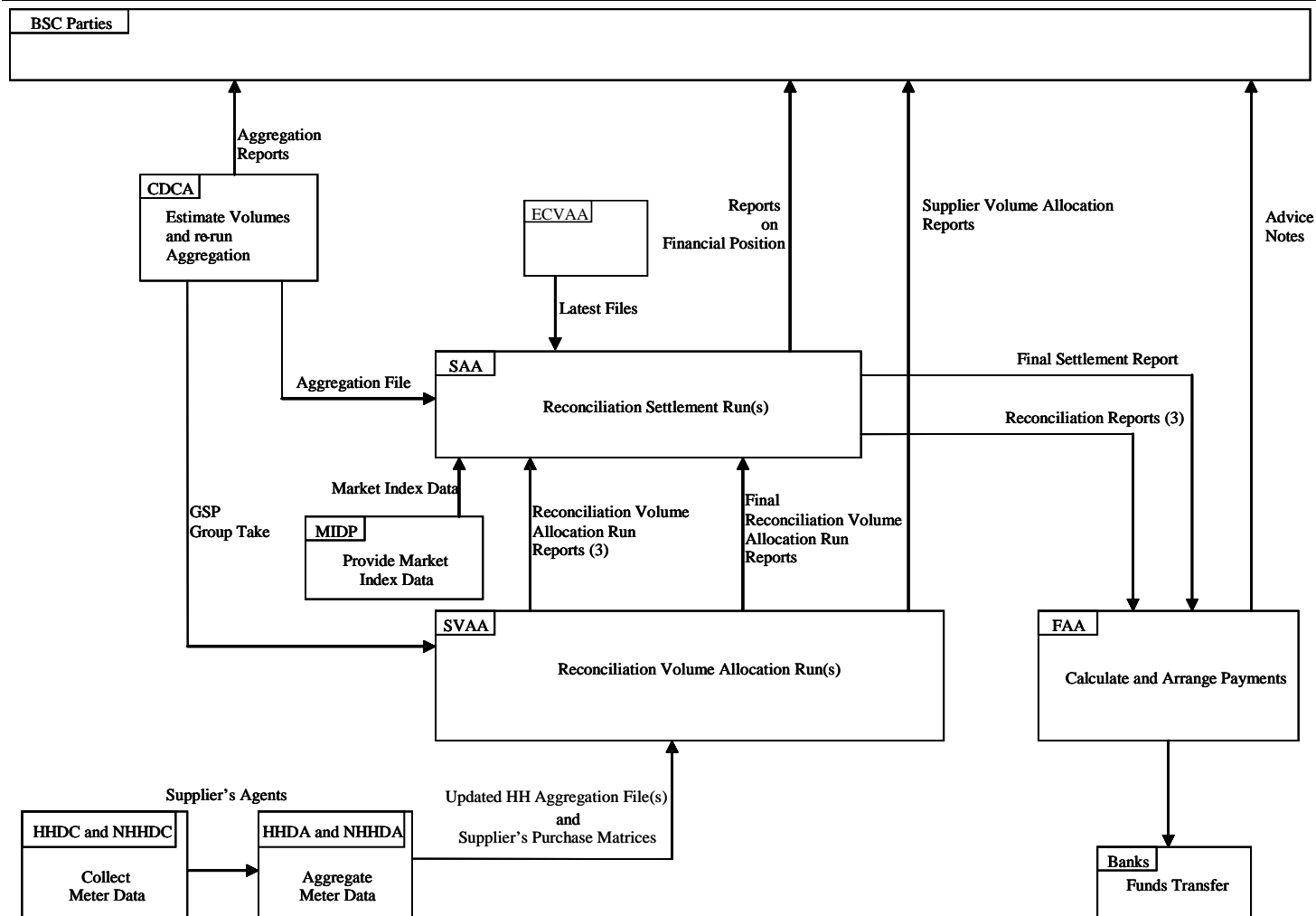

3.5 Replacement Reserve Process

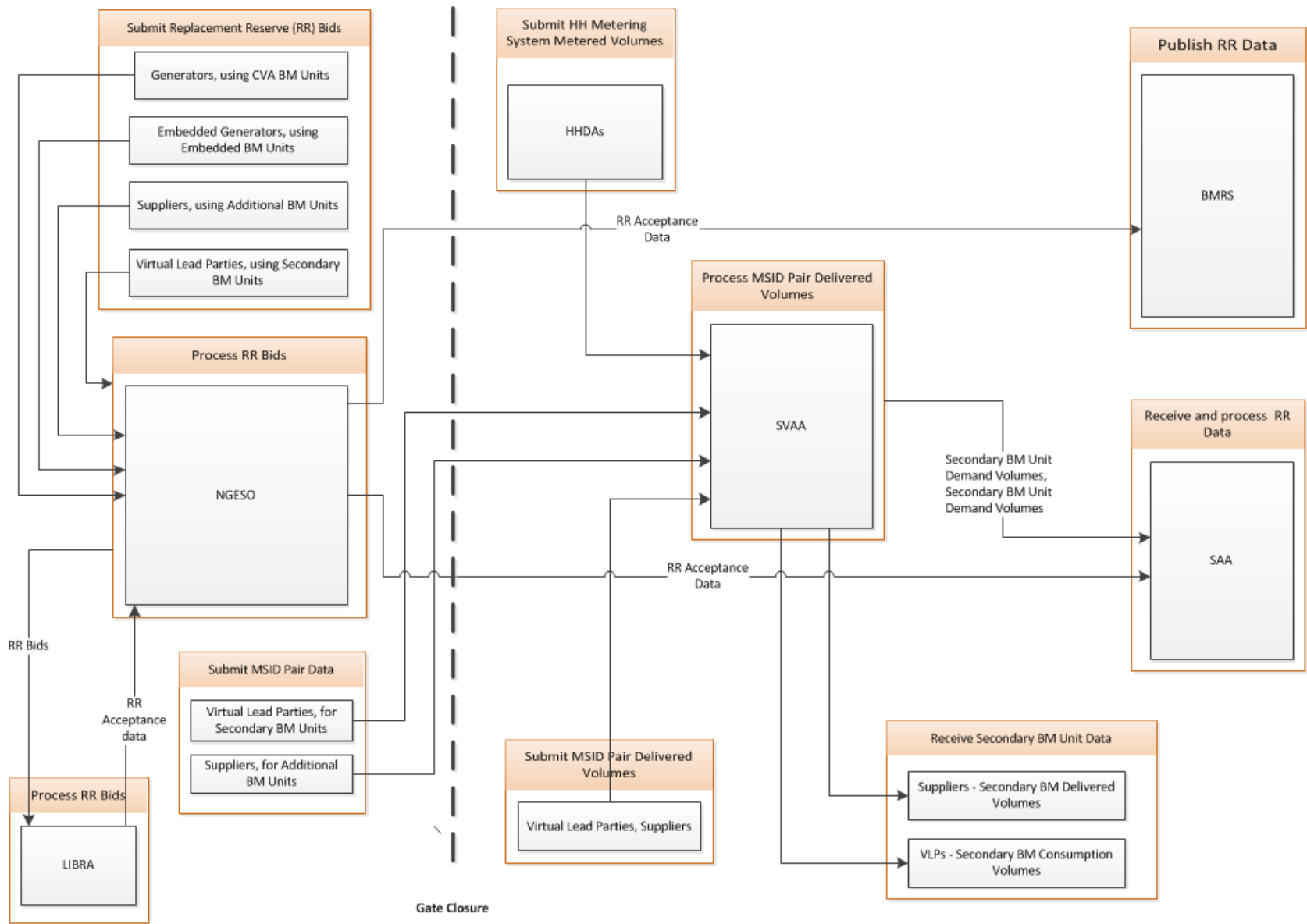

4 Interface and Timetable Information

4.1 Interim Information and Initial Settlement Timetable and Settlement Reports

This section covers the tasks required for the Interim Information and Initial Settlement Runs. The Interim Information run is carried out at approximately 5 WD, with no associated Payment Date. The Initial Settlement Run is carried out at approximately 16 WD, with an associated Payment Date of approximately 20 – 21 WD.

Ref	Task	Responsibility	Time-scale
1	Send to ECVAA Energy Contract Volume Notifications	ECVNA	To be received by ECVAA before the Submission Deadline
2	Send to ECVAA: Meter Volume Reallocation Notifications	MVRNA	To be received by ECVAA before the Submission Deadline
3	Send the following information (for each BM Unit in respect of which the Lead Party is obliged to submit a FPN or has chosen to submit a FPN) to the NETSO: Final Physical Notification Data Bid / Offer Data (Required only if trading in Balancing Mechanism) Dynamic Data	Lead Parties	To be received by the NETSO before Gate Closure
4	Send to SVAA (for each Baseline BM Unit, and for MSID Pairs or AMSID Pairs which are not Baseline or Inactive: Submitted Expected Volumes	Lead Parties	To be received by SVAA before Gate closure for a Settlement Period
5	Send to BMRA: Market Index Data	Market Index Data Providers	Target by end of Settlement Period
6	Accept Bids and Offers as required to meet forecast and actual system conditions. Acceptances which are taken to resolve transmission constraints are SO-Flagged.	NETSO	Not later than 15 minutes following the issue of an Acceptance; or In the case of an Emergency Instruction, as soon as reasonably practicable.
7	Energy Transfer and Metering	Lead Parties	Settlement Period

Ref	Task	Responsibility	Time-scale
8	<p>Send the following information to BMRA (for information / storage) for each BM Unit in respect of which the Lead Party is obliged to submit a FPN or has chosen to submit a FPN to the NETSO:</p> <p>Maximum Export Limit Maximum Import Limit Final Physical Notification Data Dynamic Data Bid Offer Data (for those BM Units for which such data has been provided) Acceptance Data System related Data BM Unit Applicable Balancing Services Volume Data Replacement Reserve Data</p>	NETSO	<p>Target Times:</p> <p>Not later than 5 minutes following receipt</p> <p>Not later than 15 minutes following Gate closure for each Settlement Period</p> <p>Not later than 1200 hrs each day</p>
9	<p>Send Final Physical Notification Data to ECVAA.</p> <p>Calculate Indicative System Buy Price and Indicative System Sell Price and publish relevant data</p>	BMRA	<p>Upon receipt from the NETSO.</p> <p>15 + CADL minutes after end of Settlement Period.</p>
10	<p>Send the following information to SAA to enable Settlement:</p> <p>Final Physical Notification Data Balancing Services Adjustment Data Bid Offer Data Acceptance Data Any Dynamic Data received by the NETSO during the Settlement Day BM Unit Applicable Balancing Services Volume Data</p>	BMRA	<p>The next day following the Settlement Day for Balancing Services Adjustment Data, and by 15 minutes following the end of the Settlement Day for the other items.</p> <p>Within 2 Business Days following the relevant Settlement Period for BM Unit Applicable Balancing Services Volume Data</p>
11	<p>Interrogate Metering Systems registered by Parties with the CRA and collect consumption data.</p> <p>Send to relevant Parties: Raw Meter Data together with any validation criteria</p>	CDCA	Send out by Settlement Day +1 (1300hrs)
12	<p>Send to SVAA: Tele-switch data</p>	Tele-switch Agent	By +1 WD (by 1000hrs)
13	<p>Obtain the following data from relevant authorised providers:</p> <p>Daily temperature parameters by GSP Group Sunset times by GSP Group (annually) Perform Profile Production Run Send Profile Reports to Suppliers and NHHDCs</p>	SVAA	<p>By +1 WD (by 1000hrs)</p> <p>By +1 WD (by 1700hrs)</p>

Ref	Task	Responsibility	Time-scale
14	Send to SAA: BM Unit Metered Volumes for the BM Units of each Interconnector User for each Interconnector	IA	By +1 WD
15	Send to SAA: Market Index Data	Market Index Data Providers	By +1 WD
16	Send to SVAA MSID Pair Delivered Volumes for procured balancing services MSID Pair Delivered Volumes or AMSID Pair Delivered Volumes for procured balancing services	VLP or AMVLP	By +1 WD (by 1700hrs)
17	Suppliers raise query on Daily Profile Production Reports if necessary and log with Dispute Administrator	Supplier	By +3 WD (by 1000hrs)
<u>[MHHS]</u> <u>18</u>	<u>Ensure Agents send to SVAA: Consumption data from all Data Services (SDS, ADS and UMSDS)</u>	<u>Suppliers</u>	<u>By +4 Calendar Days (0000hrs)</u>
<u>1918</u>	Resolve Daily Profile Production query	SVAA	By +4 WD (by 1300hrs)
<u>2019</u>	Amend Profile variables ready to re-run Daily Profile Production, if necessary	SVAA	By +4 WD (by 1500hrs)
<u>2120</u>	If re-run of Daily Profile Production required then carry this out and send revised Daily Profile Production Reports to relevant Suppliers	SVAA	By +4 WD (by 1730hrs)
<u>2224</u>	Collate information for use in the Interim Information Run Send to SAA: Meter Volume Reallocation Notification, by BM Unit for each Settlement Period Account Bilateral Contract Volumes for each Settlement Period by BSC Party	ECVAA	In accordance with SAA Settlement Calendar

Ref	Task	Responsibility	Time-scale
2322	<p>Carry out CDCA Aggregation for Interim Information Volume Allocation Run using the latest available data, i.e. valid actual meter data and/or agreed estimated meter data (for all missing or invalid readings) and the latest available approved Line Loss Factors, Aggregation Rules, Registration Data and Meter Technical Details.</p> <p>Send to SAA: BM Unit Metered Volumes for each BM Unit GSP Group Take Interconnector Metered Volumes</p> <p>Send to SVAA: GSP Group Take</p> <p>Send to BSC Parties: GSP Group Take</p> <p>Send to Lead Party and NETSO BM Unit Aggregation Report</p>	CDCA	By + 4 WD (0900hrs)
2423	<p>Ensure Agents send to SVAA: Half Hourly Aggregation Files from HHDAs Half Hourly Metering System Metered Volumes from HHDAs Supplier Purchase Matrices from NHDAs</p>	Suppliers	By +4 WD (0900hrs)
2524	<p>Carry out Interim Information Volume Allocation Run</p> <p>Calculate the Supplier Volume Allocations for each BM Unit</p>	SVAA	By +4 WD (from 0900hrs)
[MHHS] 26	<u>Carry out Load Shaping Run and publish Load Shape data</u>	<u>SVAA</u>	<u>By +4 Calendar Days (1200hrs)</u>
2725	<p>Send to SAA: BM Unit Metered volumes for Supplier BM Units Secondary BM Units Demand Volumes Secondary BM Unit Delivered Volumes <u>Supplier BM Unit Non-Chargeable Demand</u></p>	SVAA	For receipt by + 5 WD (0900hrs)
2826	Send Interim Information Volume Allocation Run Reports to relevant Suppliers	SVAA	By +5 WD
[MHHS] 2927	<p>Carry out Interim Information Settlement Run using data from CDCA, ECVAA, SVAA, NETSO and MIDPs and send relevant reports to Parties.</p> <p>Issue IIR Credits/Debits Report to ECVAA. <u>Issue BM Unit Non-Chargeable Demand Report to the EMR Settlement Company. Publish TLM-Adjusted Non-Chargeable Demand Report on Elexon Portal.</u></p>	SAA	By + 5 WD or later if delayed in accordance with the Code

Ref	Task	Responsibility	Time-scale
3028	Implement SVAA resolution on profile query or request arbitration from Disputes Administrator	Supplier	By + 5 WD (by 1600hrs)
[MHHS] 31	<u>Ensure Agents send to SVAA: Consumption data from all Data Services (SDS, ADS and UMSDS)</u>	<u>Suppliers</u>	<u>By +6 WD (0000hrs)</u>
3229	Communicate outcome of arbitration to affected Suppliers and SVAA	Dispute Administrator	By +7 WD (by 1000hrs)
3330	If arbitration against SVAA, amend profile variables ready to re-run Daily Profile Production	SVAA	By +7 WD (by 1430hrs)
3431	Implement results from arbitration and send revised profiles to affected Suppliers	SVAA	By +7 WD (by 1800hrs)
3532	Send MSID Pair Delivered Volumes to SVAA	NETSO	By +11 WD ²
3633	Estimate volumes for missing or disputed data in accordance with the Code. Carry out CDCA Aggregation for Initial Volume Allocation Run using the latest available data i.e. valid actual meter readings and/or any agreed estimates and the latest available approved Line Loss Factors, Aggregation Rules, Registration Data and Meter Technical Details. Send to Parties: GSP Group Take Send to Lead Party and NETSO BM Unit Aggregation Report Send to SVAA: GSP Group Take Send to SAA: CDCA Aggregation File	CDCA	For receipt by +14 WD
3734	Ensure Agents send to SVAA: Half Hourly Aggregation Files from HHDAs Half Hourly Metering System Metered Volumes from HHDAs Supplier Purchase Matrices from NHHDAs Half Hourly Asset Metering System Metered Volumes from HHDCs	Suppliers AMVLPs	By +14 WD
3735	Carry out Initial Volume Allocation Run Calculate the Supplier Volume Allocations for each BM Unit	SVAA	By +15 WD (from 0900hrs)

² Where such data is available to the NETSO

Ref	Task	Responsibility	Time-scale
3836	Send to SAA: BM Unit Metered volumes for Supplier BM Units Secondary BM Units Demand Volumes Secondary BM Unit Delivered Volumes Supplier BM Unit Non BMU ABSVD Volume ³	SVAA	For receipt by + 16 WD (0900hrs)
3937	Send: Relevant Reports to NETSO DUoS Report to Distribution Businesses Initial Volume Allocation Run Reports to Suppliers	SVAA	By + 16 WD (before 1230hrs)))By + 17 WD)
4037	Carry out Initial Settlement Run using latest files from NETSO, ECVAA, CDCA and SVAA and MIDPs; and send relevant reports to BSC Parties. Send Settlement Report to FAA	SAA	By +16 WD (subject to SAA Settlement Calendar) or later if delayed in accordance with the Code For receipt by + 17 WD (0900hrs) (subject to Payment Calendar)
4138	Receive Settlement Report from SAA Calculate Payments	FAA	By +17–18 WD (subject to Payment Calendar)
4239	Send Advice Notes to Payment Parties	FAA	By +17–18 WD (subject to Payment Calendar)
4340	Funds transfers between Parties' Banks	FAA	By +20–21 WD (subject to Payment Calendar)

³ Relating to the MSID Pair Delivered Volumes received by the SVAA

4.2 Reconciliation Timetable and Settlement Reports

This section covers all Timetabled Volume Allocation Runs and all Timetabled Reconciliation Settlement Runs. The tasks required for the Interim Information and Initial Settlement Runs are defined in Section 4.1.

The following tasks are repeated at:

T = approximately 39 WD (between 36 and 40 WD) for the 1st Reconciliation Settlement Run;

T = approximately 84 WD (between 81 and 85 WD) for the 2nd Reconciliation Settlement Run;

T = approximately 154 WD (between 151 and 155 WD) for the 3rd Reconciliation Settlement Run; and

T = approximately 292 WD (between 289 and 293 WD) for the Final Reconciliation Settlement Run.

T is the Payment Date, expressed by reference to the Settlement Day.

In each case, the first figure reflects the target to be used in preparing the Payment Calendar, and all dates must be within the range specified in brackets. Precise timings for Reconciliation Settlement Runs and are governed by the Payment Calendar and/or SAA Settlement Calendar for the relevant period.

It should be noted that all tasks relating to all Timetabled Volume Allocation Runs and all Timetabled Reconciliation Settlement Runs may also be repeated in support of a Post Final Settlement Run up to and including 28 months after the Settlement Day⁴.

Ref	Task	Responsibility	Time-scale (*)
<u>[MHHS]</u> <u>1</u>	<u>Ensure Agents send to SVAA:</u> <u>Revised Consumption data from all Data Services</u> <u>(SDS, ADS and UMSDS)</u>	<u>Suppliers</u>	<u>When Consumption or estimates</u> <u>are revised</u>
<u>2+</u>	Ensure Agents send to SVAA: Revised Half Hourly Aggregation Files from HHDAs Half Hourly Metering System Metered Volumes from HHDAs Revised Supplier Purchase Matrices from NHDAs	Suppliers	By T – 6 WD Note: Dependent on SVAA Calendar

⁴ Note that that Post-Final Settlement or Volume Allocation Runs may be requested after 28 months, but only for the purposes of the Rectification of Past Notification Error

Ref	Task	Responsibility	Time-scale (*)
32	<p>Estimate volumes for missing or disputed data in accordance with the Code.</p> <p>Re-run Aggregation Process using the latest available data i.e. valid actual meter data and/or any agreed estimates and the latest approved Line Loss Factors, Aggregation Rules, Registration Data and Meter Technical Details applicable for the relevant Settlement Day.</p> <p>Send to Parties: CDCA Aggregation Reports</p> <p>Send to SVAA: GSP Group Take</p> <p>Send to SAA: CDCA Aggregation File</p>	CDCA	By T – 6 WD Note: Dependent on SAA Settlement Calendar
43	<p>Carry out Reconciliation Volume Allocation Run</p> <p>Calculate the Supplier Volume Allocation for each BM Unit.</p>	SVAA	By T – 5 WD Note: Dependent on SVAA Calendar
54	<p>Send to SAA</p> <p>BM Unit Metered Volumes for Supplier BM Units</p> <p>Secondary BM Units Demand Volumes</p> <p>Secondary BM Unit Delivered Volumes</p> <p>Supplier BM Unit Non BMU ABSVD Volume</p> <p><u>Supplier BM Unit Non-Chargeable Demand</u></p>	SVAA	For receipt by T – 4 WD (0900hrs) Note: Dependent on SVAA Calendar
65	<p>Send:</p> <p>Relevant Reports to NETSO</p> <p>Updated DUoS Report to Distribution Businesses</p> <p>Reconciliation Volume Allocation Run Reports to Suppliers</p>	SVAA	By T – 4 WD (before 1230hrs))) By T – 3 WD)
7 *6*	<p>Carry out Reconciliation Settlement Run using latest available files from NETSO, ECVAA, CDCA and SVAA and MIDP</p> <p>Send to FAA</p> <p>Reconciliation Settlement Report</p> <p>Send to BSC Parties: Reports on financial position</p> <p><u>Send to EMR Settlement Company</u></p> <p><u>BM Unit Non-Chargeable Demand Report</u></p>	SAA	By T – 4 WD For receipt by T – 3 (0900hrs)
87	<p>Receive Reconciliation Settlement Report from SAA (Notification Date)</p> <p>Calculate Payments</p>	FAA	By T – 3 WD
98	<p>Send to Parties</p> <p>Advice Notes</p>	FAA	By T – 3 WD
109	<p>Authorise the financial transfers between Parties' Banks (Payment Date)</p>	FAA	By T

Ref	Task	Responsibility	Time-scale (*)
1140	Send MSID Pair Delivered Volumes to SVAA	NETSO	No later than SD + 45 calendar days ⁵

(*) Precise timings are governed by the Payment Calendar and/or SAA Settlement Calendar and/or SVAA Calendar.

4.3 Produce Payment Calendar and SAA Settlement Calendar (transferred to BSCP301)

Note: this has been amended to include both FAA and SAA obligations and has been transferred to BSCP301 (Clearing, Invoicing and Payment).

5 Appendices

5.1 Interim Information Settlement Run

If the SAA detects invalid or missing data in respect of the relevant Settlement Day prior to carrying out the relevant Settlement Run for the following data items:

Final Physical Notification Data (from BMRA/NETSO)

Balancing Services Adjustment Data (from BMRA/NETSO)

Bid Offer Data (from BMRA/NETSO)

Acceptance Data (from BMRA/NETSO)

BM Unit Applicable Balancing Services Volume Data (from BMRA/NETSO)

BM Unit Metered Volumes for Interconnector BM Units (from IA)

BM Unit Metered Volumes for BM Units other than Supplier BM Units and Interconnector BM Units (from CDCA)

Metered Volume Reallocations by BM Unit (from ECVAA)

Account Bilateral Contract Volumes (from ECVAA)

GSP Group Take for each GSP Group (from CDCA)

Interconnector Metered Volumes (from CDCA); and

Market Index Data (from MIDP)

BM Unit Metered Volumes for Supplier BM Units (from SVAA)

Secondary BM Units Demand Volumes and Secondary BM Unit Delivered Volumes (from SVAA)

BM Unit Period Non-Chargeable Demand (from SVAA)

Then the SAA shall inform BSCCo and proceed in accordance with BSCCo instruction.

In the event that the SAA receives invalid or missing data and is required to consult with BSCCo, the decision on whether and what default data should be substituted shall be at the absolute discretion of BSCCo.

⁵ Where such data has not been supplied already under Section 4.1.31

When incomplete data is submitted for an Interim Information Settlement Run, section T1.4.2 of the BSC states that the SAA should form an opinion on whether the proportion of data missing is 'significant', and whether the missing data is likely to be received by the end of the next Business Day, before seeking instructions from BSCCo. In practice, however, both BSCCo and the SAA prefer that BSCCo should take the lead in reaching decisions on these issues. For this reason, the SAA informs BSCCo of missing or invalid data in all cases.

5.2 Initial Settlement Run

If the SAA does not expect to receive substantially complete and valid data in respect of the relevant Settlement Day in time to carry out the relevant Settlement Run for the following data items:

Final Physical Notification Data

Balancing Services Adjustment Data

Bid Offer Data

Acceptance Data

BM Unit Applicable Balancing Services Volume Data

BM Unit Metered Volumes for Interconnector BM Units (from IA)

BM Unit Metered Volumes for Supplier BM Units (from SVAA)

Secondary BM Units Demand Volumes and Secondary BM Unit Delivered Volumes (from SVAA)

BM Unit Metered Volumes for BM Units other than Supplier BM Units and Interconnector BM Units (from CDCA)

Metered Volume Reallocations;

Account Bilateral Contract Volumes;

GSP Group Take for each GSP Group;

Interconnector Metered Volumes; and

Market Index Data

The SAA shall consult BSCCo and proceed in accordance with the BSC under BSCCo instruction. The decision by BSCCo on whether and what default data should be substituted shall be at the absolute discretion of BSCCo.

When incomplete data is submitted for an Initial Settlement Run, [Section T1.4.5](#) of the BSC states that the SAA should form an opinion on whether the data is 'substantially complete' before seeking instructions from BSCCo. In practice, however, both BSCCo and the SAA prefer that BSCCo should take the lead in reaching decisions on these issues. For this reason, the SAA will inform BSCCo of missing or invalid data in all cases.